



STARSTRAND LED TAPE LIGHTING SYSTEM



Presentation Overview

- Introduction to StarStrand LED Tape Lighting
- StarStrand Basic Star
- StarStrand Ultima Star 24
- StarStrand Elite Star 24
- StarStrand Aqua Star 24
- StarStrand Rainbow Star 24
- StarStrand Rainbow Aqua Star 24
- StarStrand Channel Star 24
- StarStrand Rainbow Channel Star 24
- Key StarStrand Accessories
- Sample StarStrand Layouts



INTRODUCTION TO STARSTRAND LED TAPE LIGHTING

MAXIM  LIGHTING®

Introduction to StarStrand LED Tape Lighting

- StarStrand LED Tape Lighting is available in both 12V and 24V systems.
 - 12V
 - *Basic Star*
 - 24V
 - *All Other*
- StarStrand LED Tape Lighting can come in a 4-Pin or 6-Pin platforms
 - 4-Pin
 - *Basic Star*
 - *Rainbow Star 24*
 - *Channel Star 24*
 - *Rainbow Channel Star 24*
 - 6-Pin
 - *All Other*

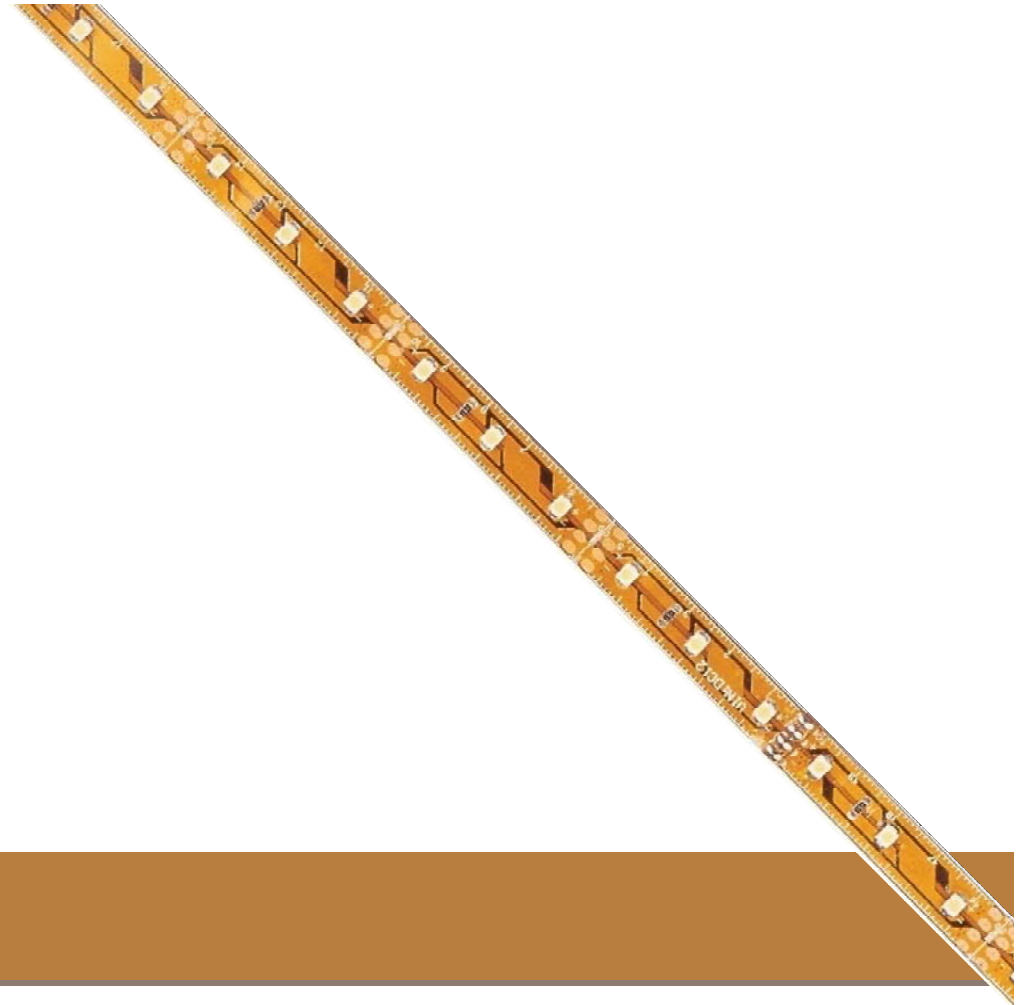

STARSTRAND BASIC STAR

LUMENS PER FOOT	82.65
WATTAGE PER FOOT	1.4
COLOR TEMPERATURE	3500 K
MAXIMUM RUN	33 FEET
FIELD CUT	2 INCHES
ETL APPROVAL	DRY LOCATION
INSTALLATION	3M TAPE

MAXIM  LIGHTING®

StarStrand Basic Star - Features

- Low power consumption of only 1.4 watts per foot
- Warm 3500 K color temperature
- Highly flexible material that is backed with 3M adhesive tape for easy installation
- No heat and no UV radiation
- Supplied in 196" length
- Can be field cut every 2"
- Includes power feeds and splicer

StarStrand Basic Star - Application

- Cove and toe kick accent lighting
- Cabinet lighting
- Architectural features
- Point of purchase displays
- Back-lighting of signs and displays
- Wine cellars
- Closets

StarStrand Basic Star – Specialized Components

1. Tape slides into channel
2. Black plastic clip slides over to secure in place

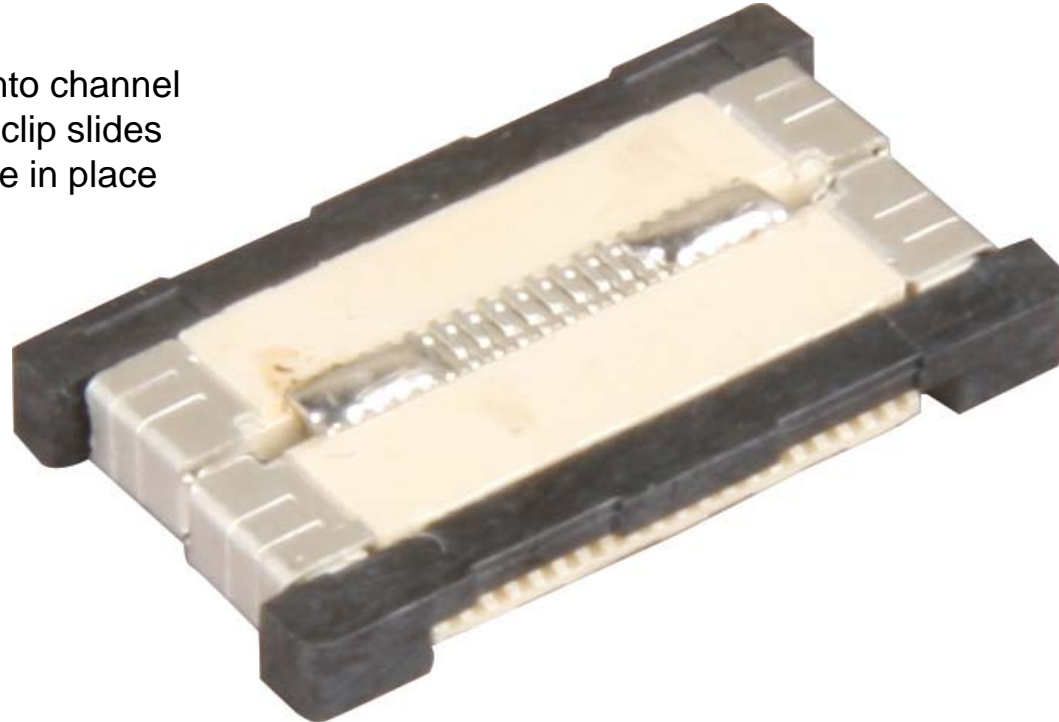

Splicer



End Power Feed



Flexible Connector



STARSTRAND ULTIMA STAR 24

LUMENS PER FOOT	243
WATTAGE PER FOOT	4.32
COLOR TEMPERATURE	3500 K
MAXIMUM RUN	70 FEET
FIELD CUT	4 INCHES
ETL APPROVAL	DAMP LOCATION
INSTALLATION	3M TAPE OR CLIPS

MAXIM  LIGHTING®

StarStrand Ultima Star 24 - Features

- Highest StarStrand lumen light output
- Long runs up to 70'
- Plastic covered to reduce static failure
- Multiple lengths with soldered connector for trouble free installation
- ETL approved for damp locations
- Highly flexible material that is backed by 3M adhesive tape for easy installation
- Can be field cut every 4 inches

StarStrand Ultima Star 24 - Application

- Office task lighting
- Under cabinet lighting
- Closets
- Work areas
- Display counters
- Steps and railings

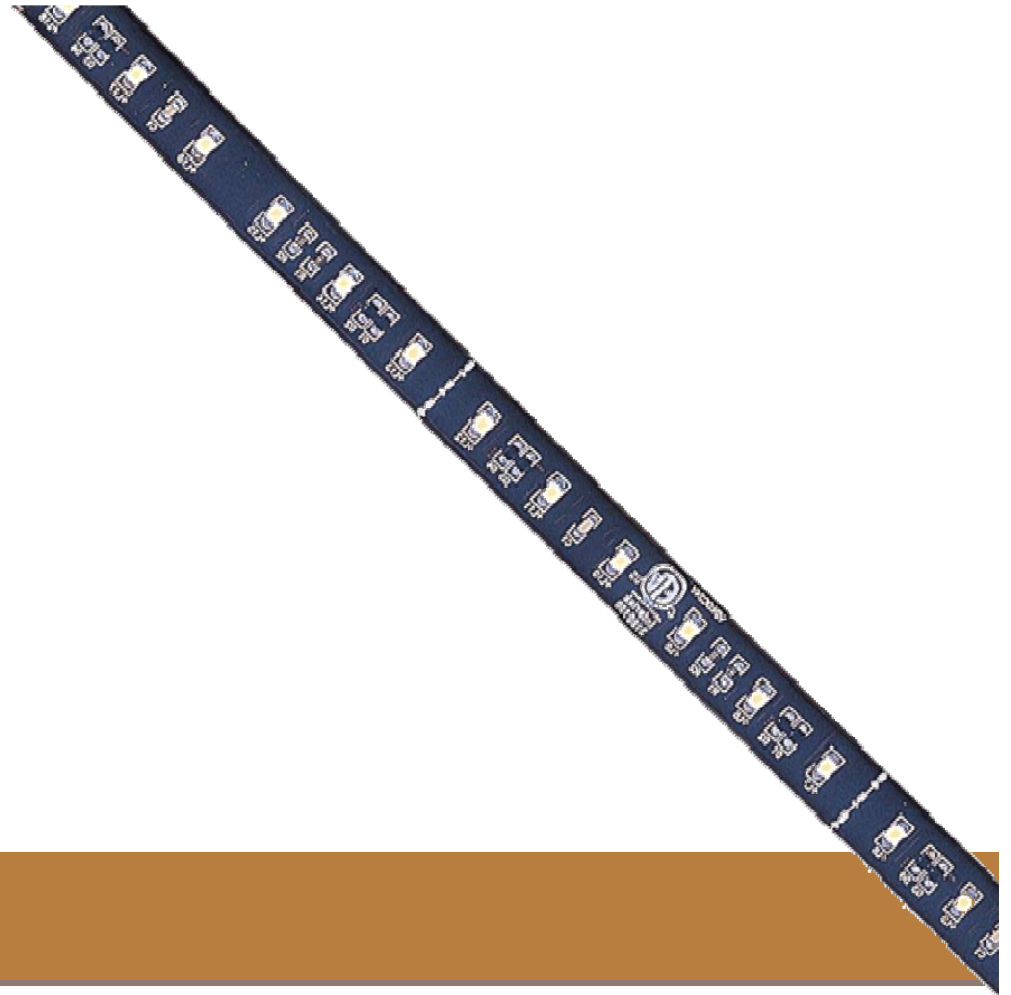

STARSTRAND ELITE STAR 24

LUMENS PER FOOT	162
WATTAGE PER FOOT	2.88
COLOR TEMPERATURE	3500 K
MAXIMUM RUN	105 FEET
FIELD CUT	4 INCHES
ETL APPROVAL	DAMP LOCATION
INSTALLATION	3M TAPE OR CLIPS

MAXIM  LIGHTING®

StarStrand Ultima Star 24 - Features

- High StarStrand lumen light output
- Long runs up to 105'
- Plastic covered to reduce static failure
- Multiple lengths with soldered connector for trouble free installation
- ETL approved for damp locations
- Highly flexible material that is backed by 3M adhesive tape for easy installation
- Can be field cut every 4 inches

StarStrand Ultima Star 24 - Application

- Cove and toe kick accent lighting
- Outdoor covered porch and patio
- Under cabinet lighting
- Step lighting
- Restaurants and lounges
- Boats and RV



STARSTRAND AQUA STAR 24

LUMENS PER FOOT	162
WATTAGE PER FOOT	2.88
COLOR TEMPERATURE	3500 K
MAXIMUM RUN	50 FEET
FIELD CUT	4 INCHES
ETL APPROVAL	WATERPROOF IP68
INSTALLATION	CHANNEL OR CLIPS

MAXIM  LIGHTING®

StarStrand Aqua Star 24 - Features

- Waterproof IP68 LED tape
- Chemical and UV resistant plastic cover
- Long runs up to 50'
- Installs into aluminum channel or plastic mounting clips
- High lumen double chip LED
- Multiple lengths with watertight IP68 connector
- Can be field cut every 4"

StarStrand Aqua Star 24 - Application

- Swimming pools and fountains
- Outdoor decks
- Step and stairs
- Landscape lighting
- Outdoor building accent lighting
- Driveway and sidewalk illumination



STARSTRAND RAINBOW STAR 24

LUMENS PER FOOT
WATTAGE PER FOOT
MAXIMUM RUN
FIELD CUT
ETL APPROVAL
INSTALLATION

RED 18, GREEN 60, BLUE 15
4.32
30 FEET
4 INCHES
DAMP LOCATION
3M TAPE OR CLIPS

MAXIM  LIGHTING®

StarStrand Rainbow Star 24 - Features

- Thousands of colors on one tape
- Long runs up to 30'
- DMX interface with optional controller
- Plastic covered to reduce static failure
- ETL approved for damp locations
- Multiple lengths with soldered connectors for trouble free installation
- Can be field cut every 4"

StarStrand Rainbow Star 24 - Application

- Cove and toe kick accent lighting
- Restaurants, bars and lounges
- Store front displays
- Back lighting of glass and acrylic panels
- Game and theatre rooms
- Discos and clubs

StarStrand Rainbow Star 24 - Components

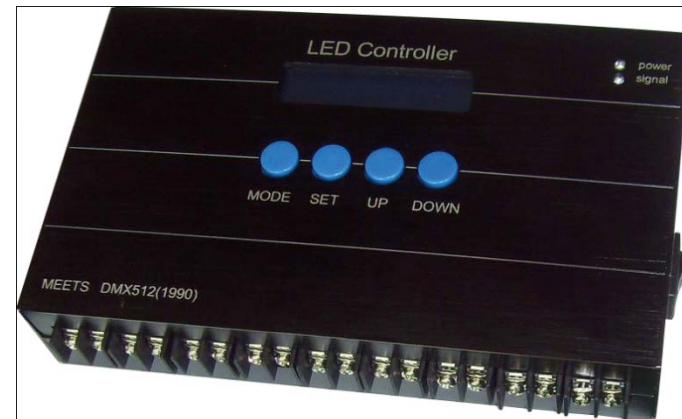



STARSTRAND RAINBOW AQUA STAR 24

LUMENS PER FOOT
WATTAGE PER FOOT
MAXIMUM RUN
FIELD CUT
ETL APPROVAL
INSTALLATION

RED 18, GREEN 60, BLUE 15
4.32
30 FEET
4 INCHES
DAMP LOCATION
WATERPROOF IP68

MAXIM  LIGHTING®

StarStrand Rainbow Aqua Star 24 - Features

- Waterproof IP68 color changing LED tape
- Nine modes of color and movement
- Chemical and UV resistant plastic cover
- Long runs up to 30'
- Installs into aluminum channel or plastic mounting clips
- Multiple lengths with watertight IP68 connectors
- Can be field cut every 4"

StarStrand Rainbow Aqua Star 24 - Application

- Swimming pools and fountains
- Outdoor living areas
- Landscape lighting
- Outdoor architectural features
- Signs
- Outdoor walkways

StarStrand Rainbow Aqua Star 24 - Components

Weatherproof RGB Controller



Weatherproof RGB Booster





STARSTRAND CHANNEL STAR 24

LUMENS PER FOOT	216
WATTAGE PER FOOT	4.32
COLOR TEMPERATURE	3500 K OR 5000 K
MAXIMUM RUN	32 FEET
ETL APPROVAL	DRY LOCATION
INSTALLATION	CLIPS
FINISHES	ALUMINUM OR BRONZE

MAXIM  LIGHTING®

StarStrand Channel Star 24 - Features

- High lumen output
- Available in both Bronze and Aluminum finish
- Clear lens for maximum light output
- Rigid aluminum channel conceals light source and provides excellent heat dissipation
- Connect end to end or with the use of connecting cables
- Available in 3500 K or 5000 K color temperature
- Includes easy to install mounting clips, both downward and 45 degree angle

StarStrand Channel Star 24 - Application

- Under cabinets and bars
- Office desk task lighting
- Retail display cabinets and counters
- Window displays
- Closet lighting



STARSTRAND RAINBOW CHANNEL STAR 24

LUMENS PER FOOT
WATTAGE PER FOOT
MAXIMUM RUN
ETL APPROVAL
INSTALLATION
FINISHES

RED 18, GREEN 60, BLUE 15
4.32
30 FEET
DRY LOCATION
CLIPS
ALUMINUM

MAXIM  LIGHTING®

StarStrand Rainbow Star 24 - Features

- Thousands of colors
- Long runs up to 30'
- DMX interface with optional controller
- Available in both Aluminum finish
- Clear lens for maximum light output
- Rigid aluminum channel conceals light source and provides excellent heat dissipation
- Connect end to end or with the use of connecting cables
- Includes easy to install mounting clips, both downward and 45 degree angle

StarStrand Rainbow Star 24 - Application

- Cove and toe kick accent lighting
- Restaurants, bars and lounges
- Store front displays
- Back lighting of glass and acrylic panels
- Game and theatre rooms
- Discos and clubs

StarStrand Rainbow Star 24 - Components

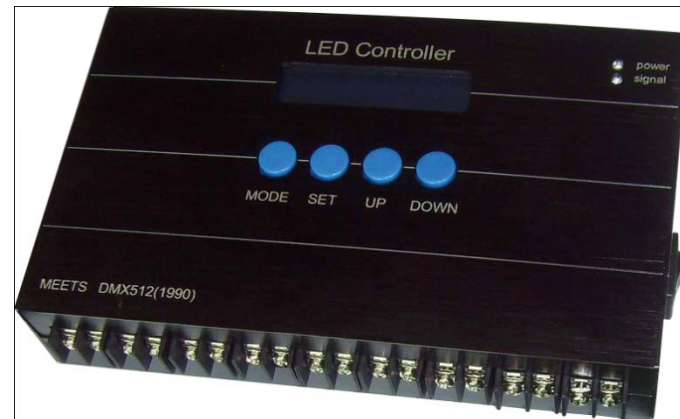

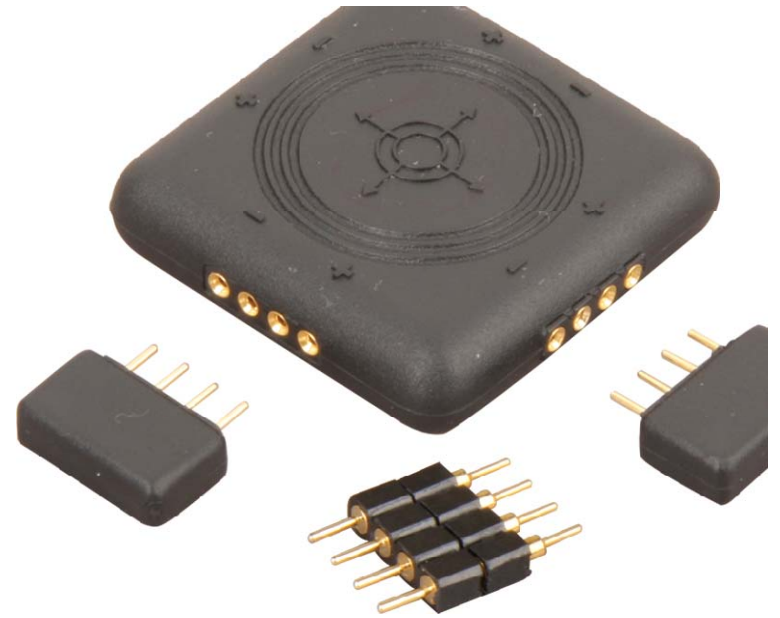

KEY STARSTRAND ACCESSORIES

Key StarStrand Accessories – Connecting Cords



STARSTRAND LED TAPE LIGHTING SYSTEM

MAXIM  LIGHTING®

Key StarStrand Accessories – Dimming Controller



STARSTRAND LED TAPE LIGHTING SYSTEM

MAXIM  LIGHTING®

Key StarStrand Accessories – 4-Way Connector



STARSTRAND LED TAPE LIGHTING SYSTEM

MAXIM  LIGHTING®

Key StarStrand Accessories – Dimming Drivers



STARSTRAND LED TAPE LIGHTING SYSTEM

Key StarStrand Accessories – Class II Drivers



STARSTRAND LED TAPE LIGHTING SYSTEM

Key StarStrand Accessories – Rough-In Terminal Blocks



STARSTRAND LED TAPE LIGHTING SYSTEM

MAXIM  LIGHTING®

STARSTRAND SAMPLE LAYOUTS

StarStrand Sample Layouts – Basic Star

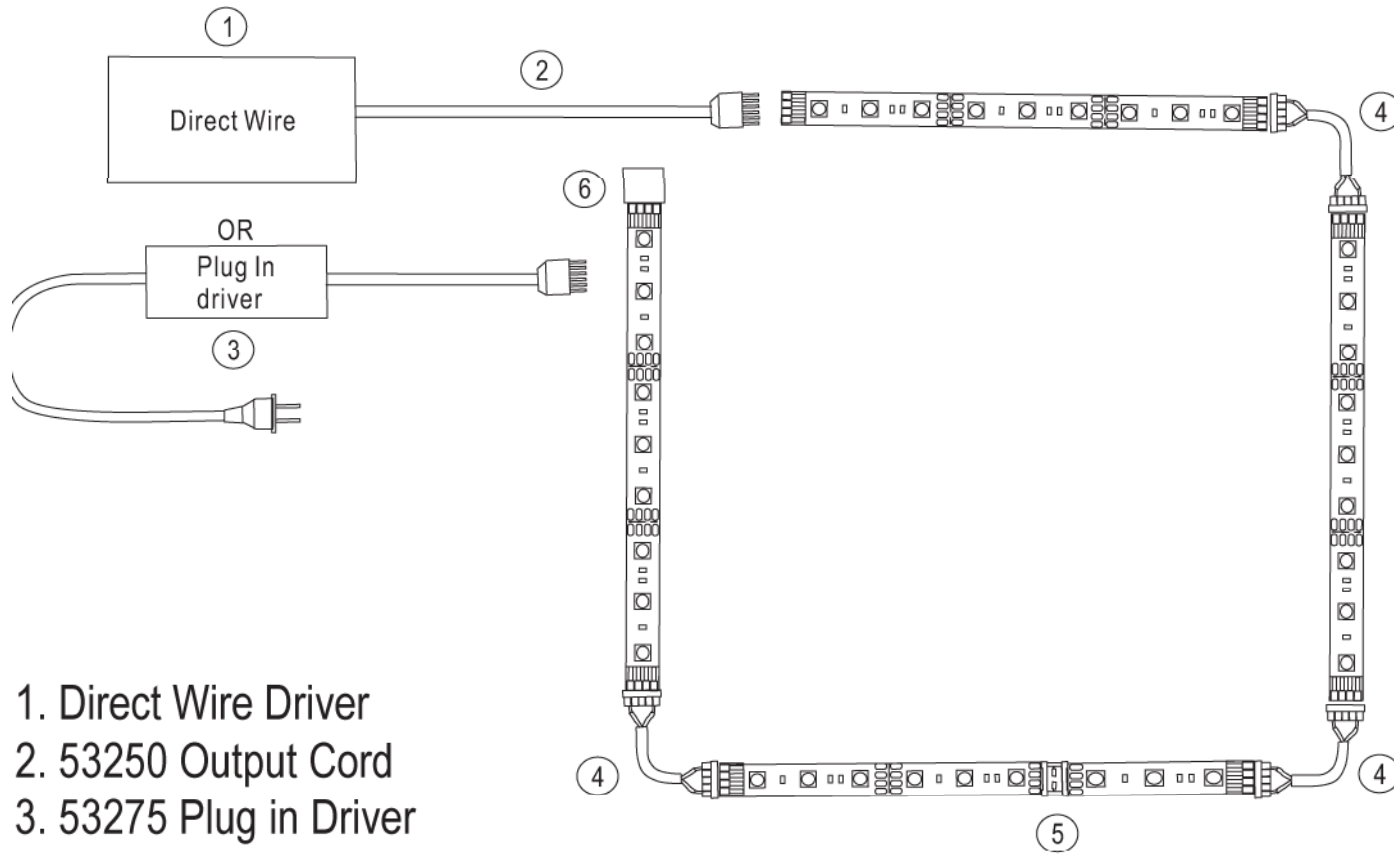

1. Direct Wire Driver
2. 53250 Output Cord
3. 53275 Plug in Driver
4. 53259 Flexible Connector
5. 53261 Tape Splicer
6. 53269 End Cap

StarStrand Sample Layouts – Ultima Star 24 / Elite Star 24

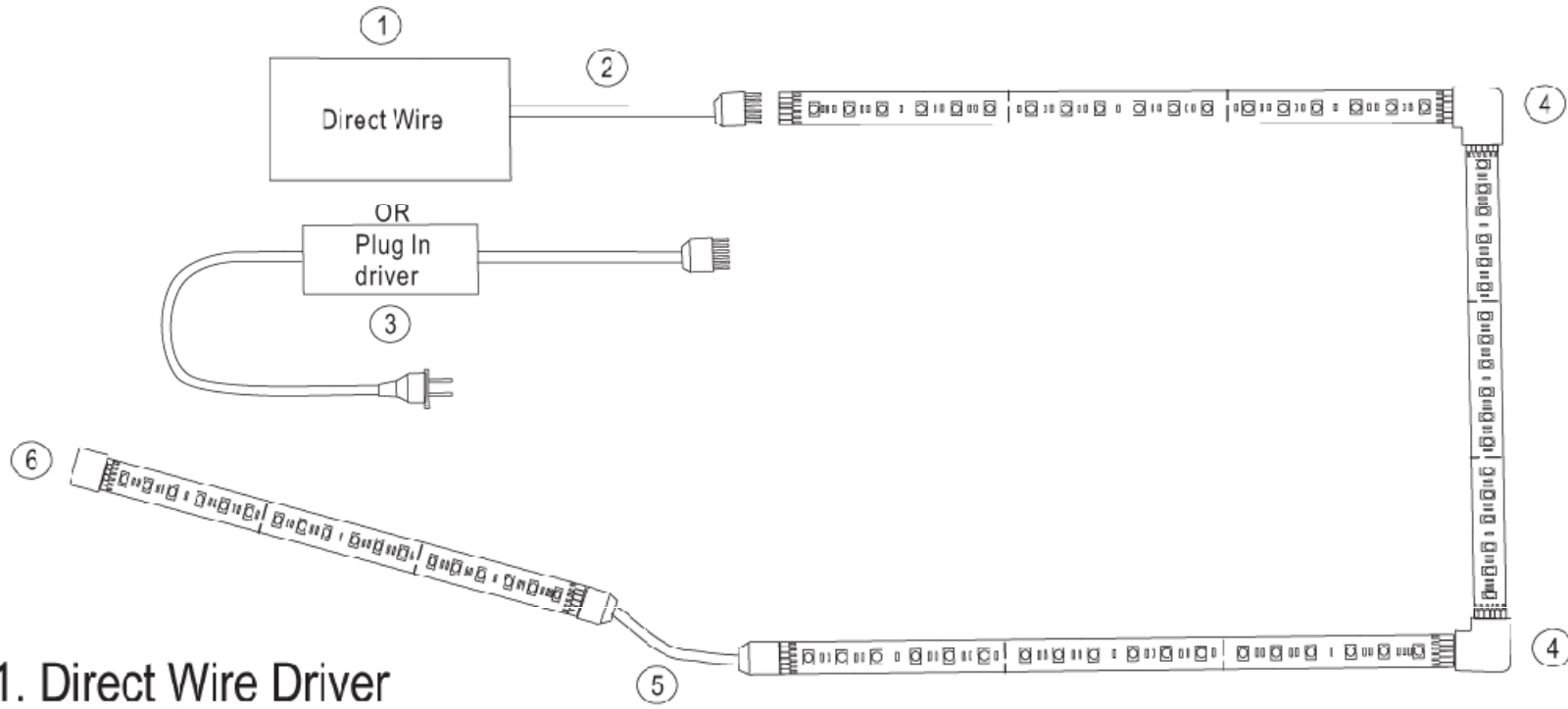

1. Direct Wire Driver
2. 53253 Output Cord
3. 53320 Plug in Driver
4. 53464 90° connector
5. 53465 5" Connector cord
6. 53469 End Cap

StarStrand Sample Layouts – Rainbow Star 24

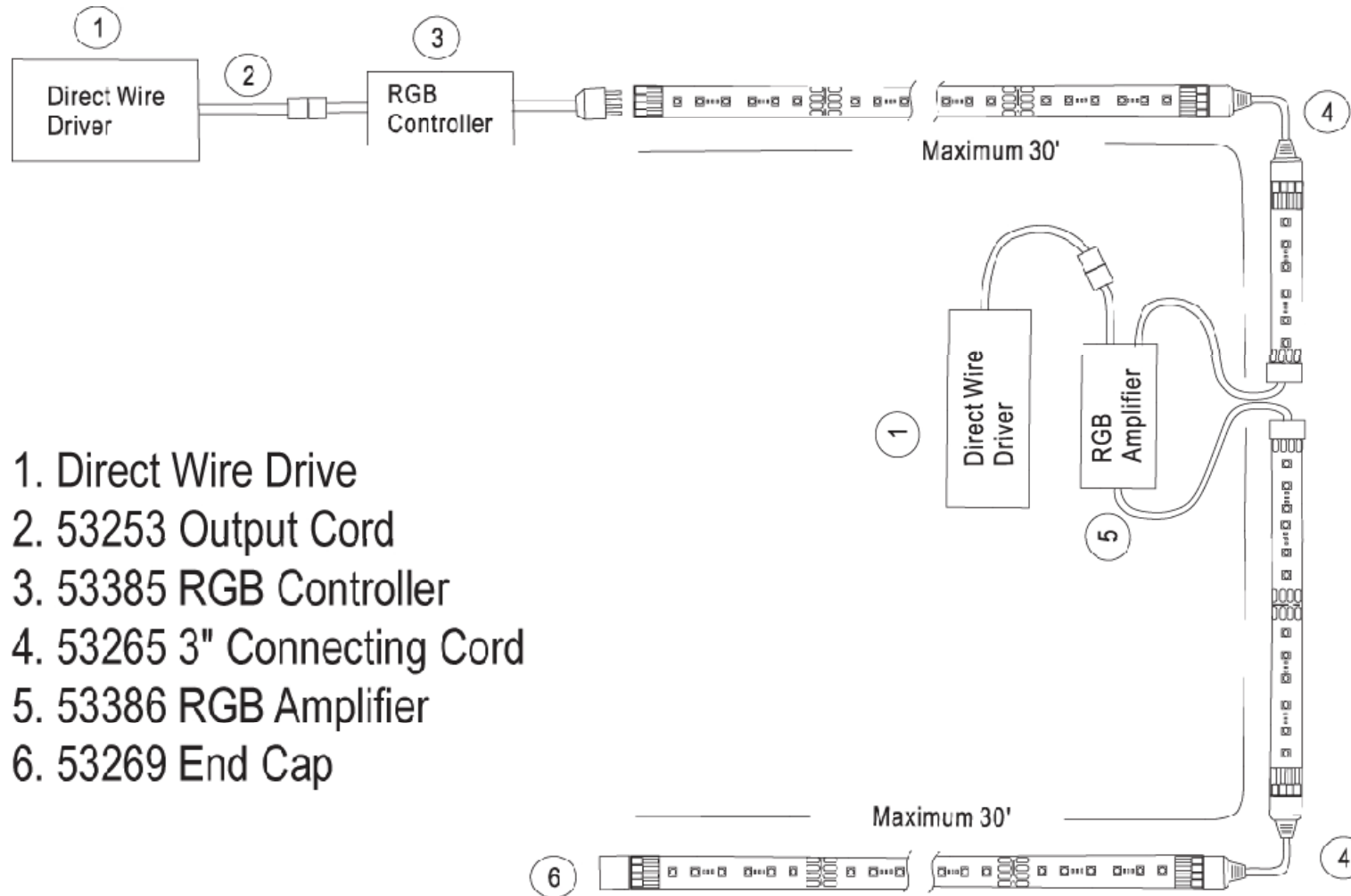

StarStrand Sample Layouts – Aqua Star 24

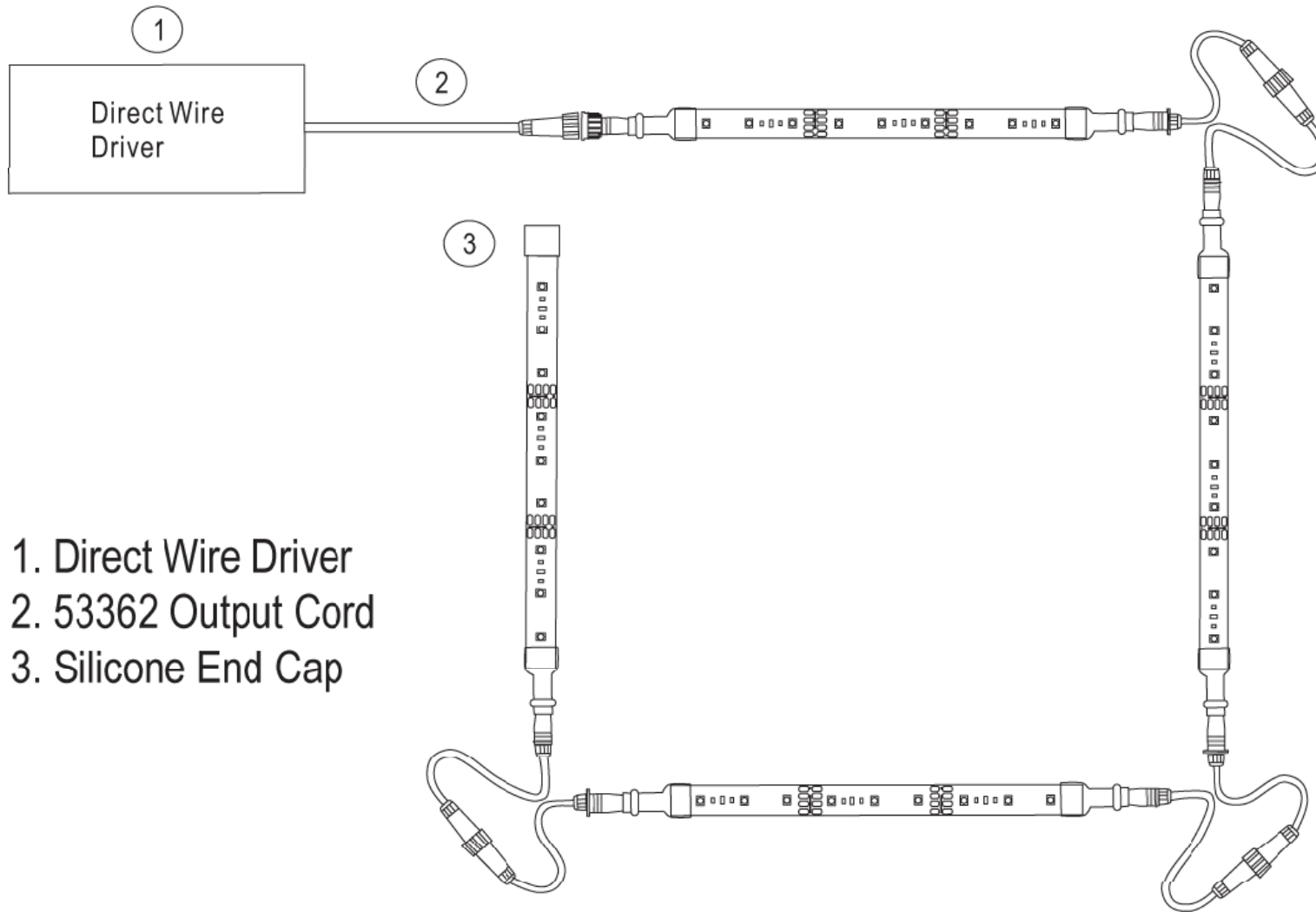

1. Direct Wire Driver
2. 53362 Output Cord
3. Silicone End Cap

StarStrand Sample Layouts – Rainbow Aqua Star 24

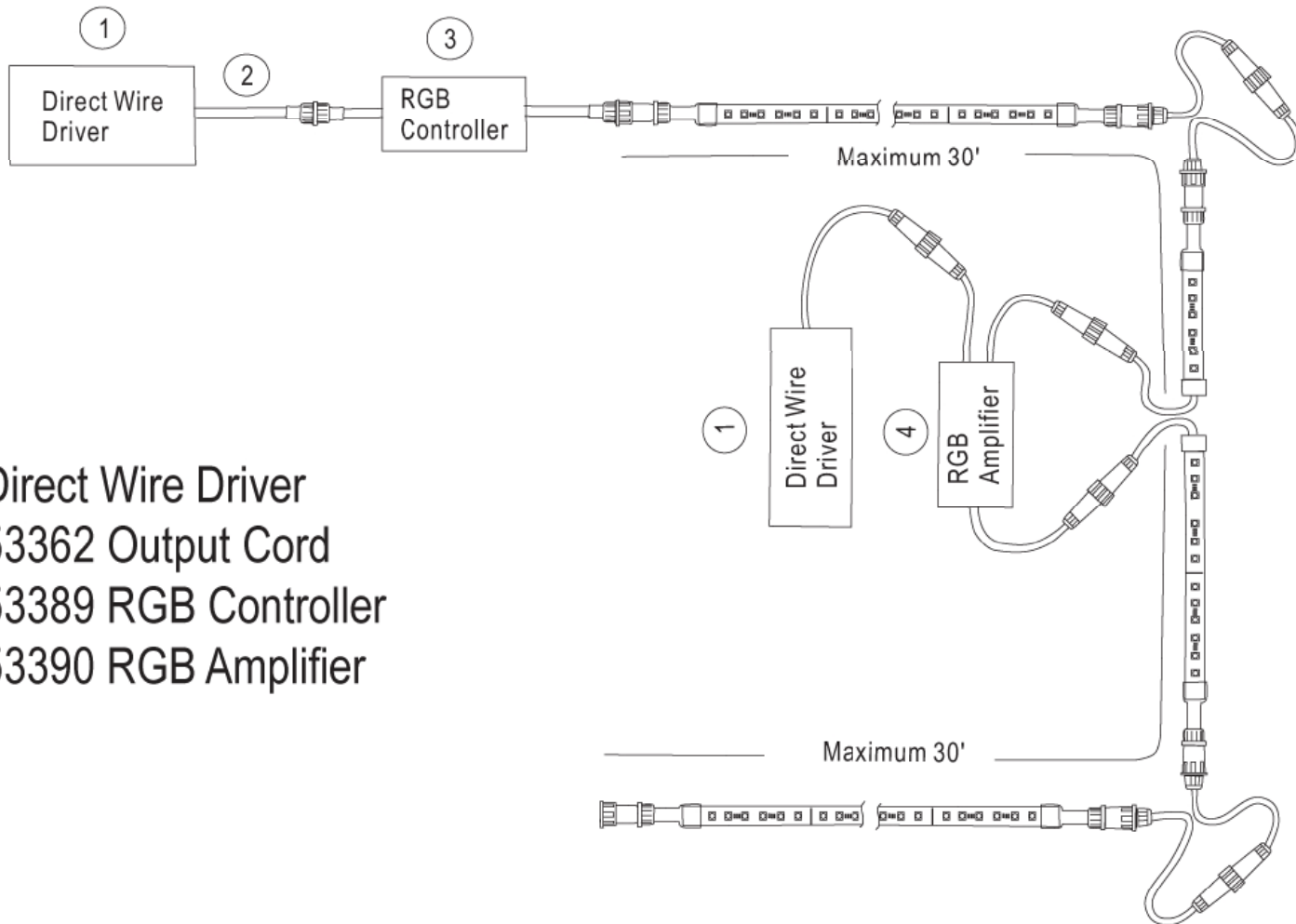

1. Direct Wire Driver
2. 53362 Output Cord
3. 53389 RGB Controller
4. 53390 RGB Amplifier

StarStrand Sample Layouts – Powered from the Middle

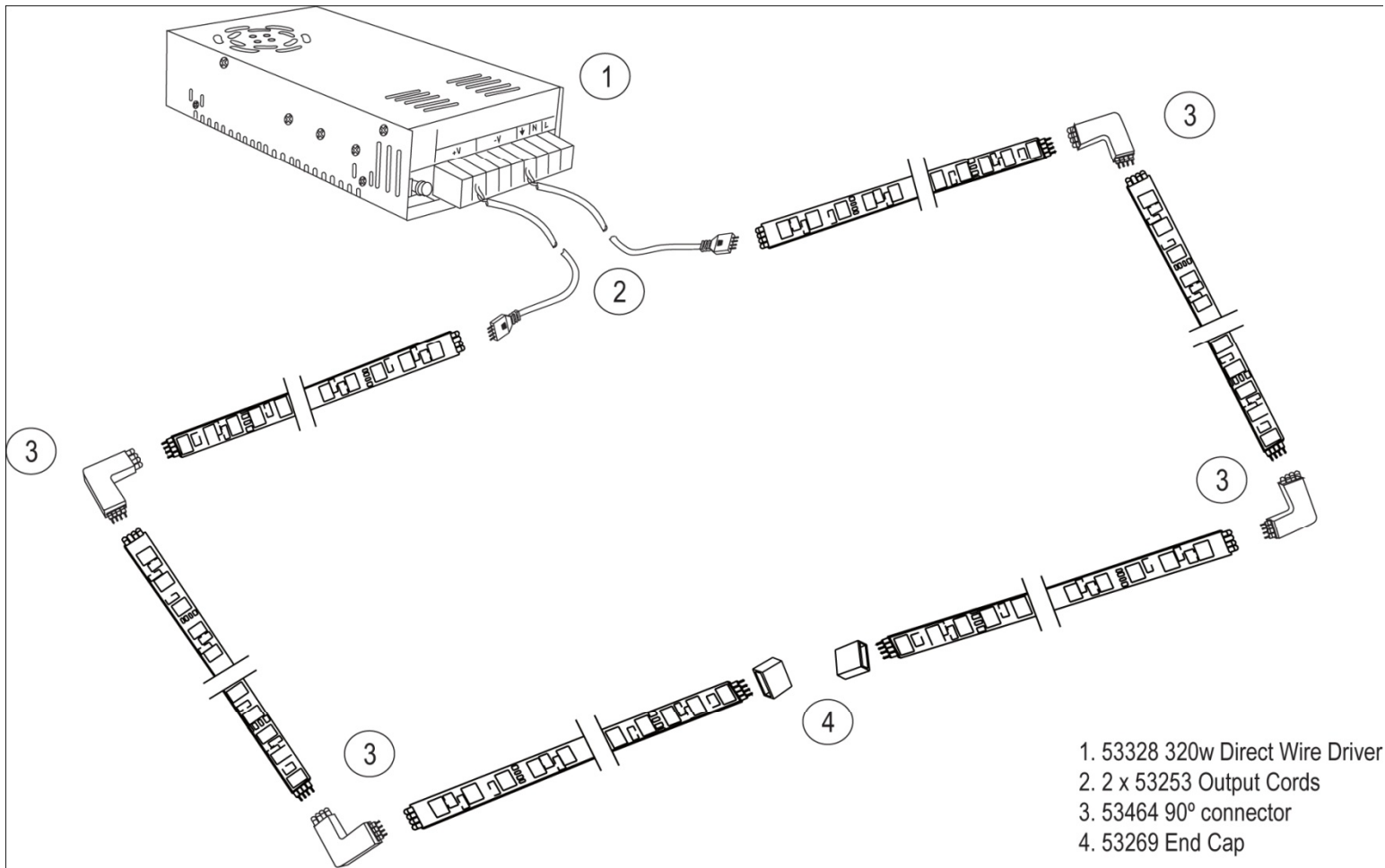

StarStrand Sample Layouts – Channel Star 24 / Rainbow Channel Star 24

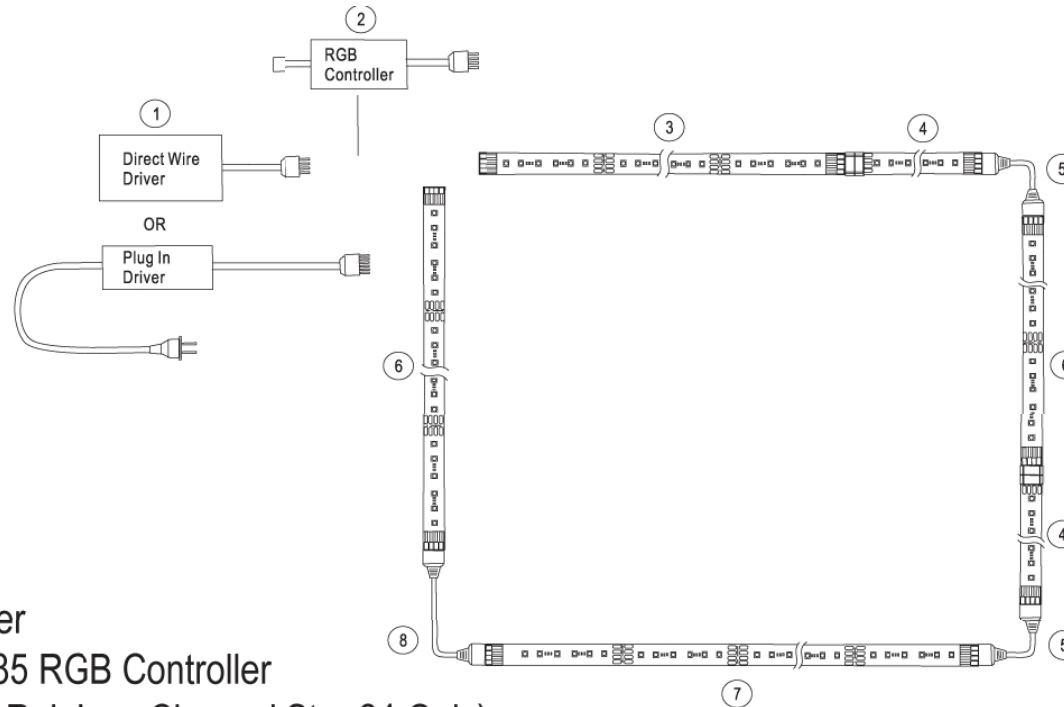

1. Driver
2. 53385 RGB Controller
(For Rainbow Channel Star 24 Only)
3. 36" Channel Star
4. 12" Channel Star
5. 53265 3" Connecting cord
6. 24" Channel Star
7. 48" Channel Star
8. 53267 13" Connecting Cord

THANK YOU FOR YOUR TIME TODAY!!

