

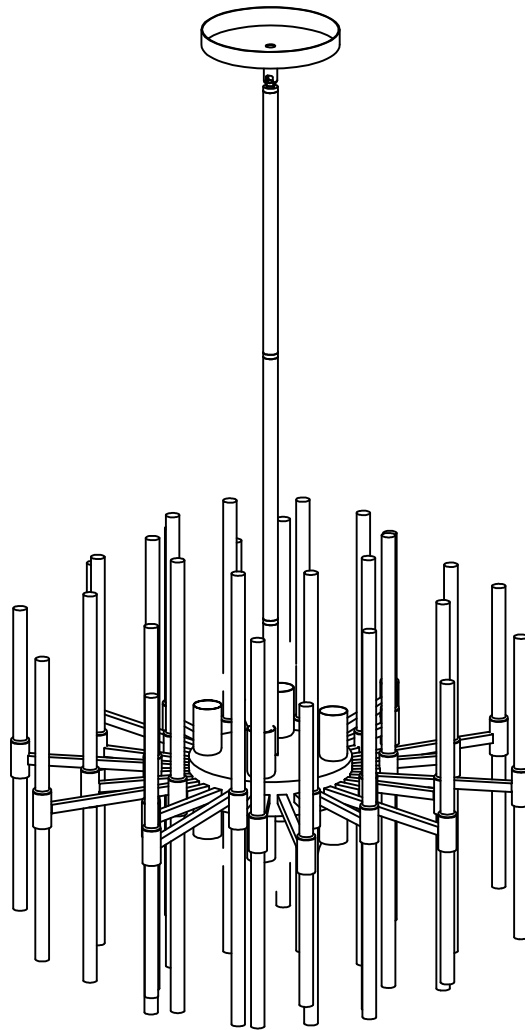

L I G H T I N G

Item/Model Number: 38405CLHR

Divine 8-Light Pendant







Lamping | Ampoule: "[8] x[E12 Candelabra] [60W] (Not Included)"





Please consult a qualified electrician prior to install

Veuillez consulter un électricien qualifié pour suspendre le luminaire et le câblage.

Made in China | Fabrique en Chine | Hecho en China

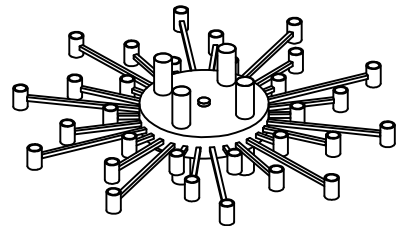
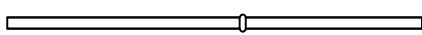
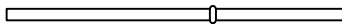
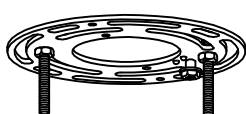
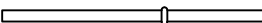
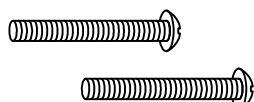
GENERAL 120V INSTRUCTIONS

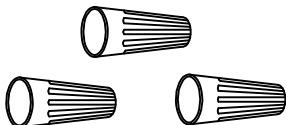
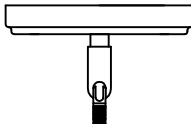
| English Before Getting Started | Français Avant de Commencer | Español Antes de Comenzar |
|--|--|---|
| Read the instructions carefully prior to assembling the product. | Lire attentivement les instructions avant d'assembler le produit. | Lea atentamente las instrucciones antes de ensamblar el producto. |
| When you open the package with a sharp tool like a box knife, be careful not to damage the components inside. | Lorsque vous ouvrez le paquet avec un outil pointu comme un couteau de coupe, veillez à ne pas endommager les composants à l'intérieur. | Cuando abra el paquete con una herramienta afilada como un cuchillo de corte, tenga cuidado de no dañar los componentes dentro. |
| Carefully remove all packaging materials and retain for future use. | Retirez soigneusement tous les matériaux d'emballage et conservez-les pour un usage ultérieur. | Retire con cuidado todos los materiales de embalaje y consérvelos para usarlos en el futuro. |
| Keep all hardware parts and packaging out of reach of children. | Conservez toutes les pièces matérielles et les emballages hors de portée des petits enfants. | Mantenga todas las piezas y embalajes de hardware fuera del alcance de los niños pequeños. |
| Choose a clean, level, spacious assembly area. Avoid hard surfaces that may damage the product. | Choisissez une zone d'assemblage propre, de niveau et spacieuse. Évitez les surfaces dures qui pourraient endommager le produit. | Elija una zona de ensamblaje limpia, nivelada y espaciosa. Evite superficies duras que puedan dañar el producto. |
| Ensure that you have all required contents for complete assembly. | Assurez-vous que vous avez tous les contenus requis pour l'assemblage complet. | Asegúrese de que tiene todos los contenidos necesarios para el ensamblaje completo. |
| Take care when lifting. Assemble the product in close proximity to where you intend to install it. | Prenez soin de soulever. Assemblez le produit à proximité de l'endroit où vous comptez positionner l'élément. | Tenga cuidado al levantar. Ensamble el producto cerca de donde tiene la intención de posicionar el artículo. |
| Do not over tighten the screws and bolts as this may damage the threads. | Ne serrez pas trop les vis et les boulons car cela pourrait endommager les filets. | No apriete excesivamente los tornillos y pernos, ya que esto puede dañar los hilos. |
| Do not let children play with this product. | Ne laissez pas les enfants jouer avec ce produit. | No permita que los niños jueguen con este producto. |
|  Risk of suffocation! Keep packaging materials away from children. |  Risque asphyxie! Tenez tous les matériaux emballage à l'écart des enfants |  Riesgo de sofocación! Mantenga los materiales de embalaje lejos de los niños. |
| Lamp Care Instructions | Entretien de la Lampe | Instrucciones de Lámparas |
| Carefully read through the instruction sheet before assembly and using the product. | Avant de procéder à l'assemblage et à l'utilisation de la lampe, lisez attentivement le mode d'emploi. | Lea cuidadosamente la hoja de instrucciones (si fue proporcionada) antes de armar y utilizar la lámpara. |
|  Caution there is a risk of shock! Disconnect from power source before assembling or cleaning. |  Pour éviter tout risque d'électrocution, débranchez la lampe de la prise électrique avant de procéder à l'assemblage ou au nettoyage de la lampe. |  Peligro por descarga eléctrica. Desconecte la lámpara de la fuente de electricidad antes de armarla o limpiarla. |
| Switch off, unplug and allow bulb to cool before replacing bulb or cleaning. | Avant de remplacer ou de nettoyer l'ampoule, éteignez et débranchez la lampe. | Apáguela, desenchúfela y deje que la bombilla se enfríe antes de reemplazarla o limpiarla. |
| Only use the recommended bulb type and do not exceed the maximum wattage as it could cause fire. | Afin d'éviter tout risque de feu, utilisez le type et la puissance d'ampoule recommandés. | Solo utilice el tipo de bombilla recomendado y no exceda la potencia eléctrica máxima ya que puede causar un incendio. |
| Check the product cord to be sure is free torn or frayed. | Ne branchez pas la lampe si son cordon d'alimentation est déchiré ou effiloché | No conecte la lámpara si el cable eléctrico está dañado o deshilachado. |
| Cleaning & Maintenance | Nettoyage et Maintenance | Limpieza y Mantenimiento |
| On polished finishes, often using talc powder can reduce the appearance of fingerprints and other smudges. | Sur les finitions polies, souvent en utilisant la poudre de talc réduit l'apparence des empreintes digitales et d'autres taches. | En acabados pulidos, a menudo usando polvo de talco reduce la aparición de huellas dactilares y otras manchas. |
| For respective shade surfaces, use the appropriate cleansers, i.e. glass cleaner, stone polish, & wood polish. | Pour les surfaces d'ombrage respectives, utilisez les nettoyeurs appropriés, c'est-à-dire le nettoyeur pour vitres, vernis à pierre et le vernis à bois. | Para las respectivas superficies de sombra, utilice los limpiadores apropiados, es decir, limpiador de vidrio, esmalte acrílico y pulido de madera. |
| Clean with soft cloth and a mild detergent. Do not use abrasive or harsh cleaners. | Nettoyer avec un chiffon doux et un détergent doux. N'utilisez pas de nettoyeur abrasif. | Utilice un trapo limpio, suave y seco que no raye ni manche la superficie cuando quite el polvo. |
| Periodically (every 90-180 days) make sure that the screws are fully tightened. | Périodiquement (tous les 90-180 jours), assurez-vous que les vis sont bien serrées. | Periódicamente (cada 90-180 días) asegúrese de que los tornillos estén bien apretados. |
| Prolonged exposure to heat sources may cause glazing, melting and scorching, or even cause color to fade. | Si le tissu subit une exposition prolongée aux sources de chaleur, il pourrait commencer à reluire, à roussir, à s'estomper ou même à se décolorer. | La exposición prolongada a las fuentes de calor causa cristalización, derretimiento, quemadura y decoloración del tapizado. |

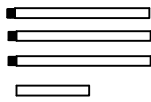
| Eng PARTS | Fra PIÈCES | Esp PARTES |
|--|---|---|
| Before getting started, ensure the package contains the following components: | Antes de comenzar, asegúrese de que el paquete contenga los siguientes componentes: | Avant de commencer, assurez-vous que le paquet contient les composants suivants: |
| <div data-bbox="79 414 143 481" style="border: 1px dashed black; border-radius: 50%; width: 30px; height: 30px; display: flex; align-items: center; justify-content: center;">A</div>  | x1 | <div data-bbox="805 313 869 380" style="border: 1px dashed black; border-radius: 50%; width: 30px; height: 30px; display: flex; align-items: center; justify-content: center;">H</div>  <div style="text-align: right; font-weight: bold;">x10</div> <p style="text-align: center;">GLS38405CL-C-N</p> <div data-bbox="805 548 869 616" style="border: 1px dashed black; border-radius: 50%; width: 30px; height: 30px; display: flex; align-items: center; justify-content: center;">I</div>  <div style="text-align: right; font-weight: bold;">x10</div> <p style="text-align: center;">GLS38405CL-B-N</p> |
| <div data-bbox="79 772 143 840" style="border: 1px dashed black; border-radius: 50%; width: 30px; height: 30px; display: flex; align-items: center; justify-content: center;">B</div>  | x1 | <div data-bbox="805 772 869 840" style="border: 1px dashed black; border-radius: 50%; width: 30px; height: 30px; display: flex; align-items: center; justify-content: center;">J</div>  <div style="text-align: right; font-weight: bold;">x10</div> <p style="text-align: center;">GLS38405CL-A-N</p> |
| <div data-bbox="79 996 143 1064" style="border: 1px dashed black; border-radius: 50%; width: 30px; height: 30px; display: flex; align-items: center; justify-content: center;">C</div>  <p style="text-align: center;">#8-32 x1.25"</p> | x2 | <div data-bbox="805 996 869 1064" style="border: 1px dashed black; border-radius: 50%; width: 30px; height: 30px; display: flex; align-items: center; justify-content: center;">K</div>  <div style="text-align: right; font-weight: bold;">x8</div> <p style="text-align: center;">BULB(Not Included)</p> |
| <div data-bbox="79 1232 143 1299" style="border: 1px dashed black; border-radius: 50%; width: 30px; height: 30px; display: flex; align-items: center; justify-content: center;">D</div>  | x3 | |
| <div data-bbox="79 1456 143 1523" style="border: 1px dashed black; border-radius: 50%; width: 30px; height: 30px; display: flex; align-items: center; justify-content: center;">E</div>  | x1 | |
| <div data-bbox="79 1691 143 1758" style="border: 1px dashed black; border-radius: 50%; width: 30px; height: 30px; display: flex; align-items: center; justify-content: center;">F</div>  | x2 | |
| <div data-bbox="79 1915 143 1982" style="border: 1px dashed black; border-radius: 50%; width: 30px; height: 30px; display: flex; align-items: center; justify-content: center;">G</div>  <p style="text-align: center;">STR06206HR-NK 1PCS STR06212HR-NK 3PCS</p> | x1 | |

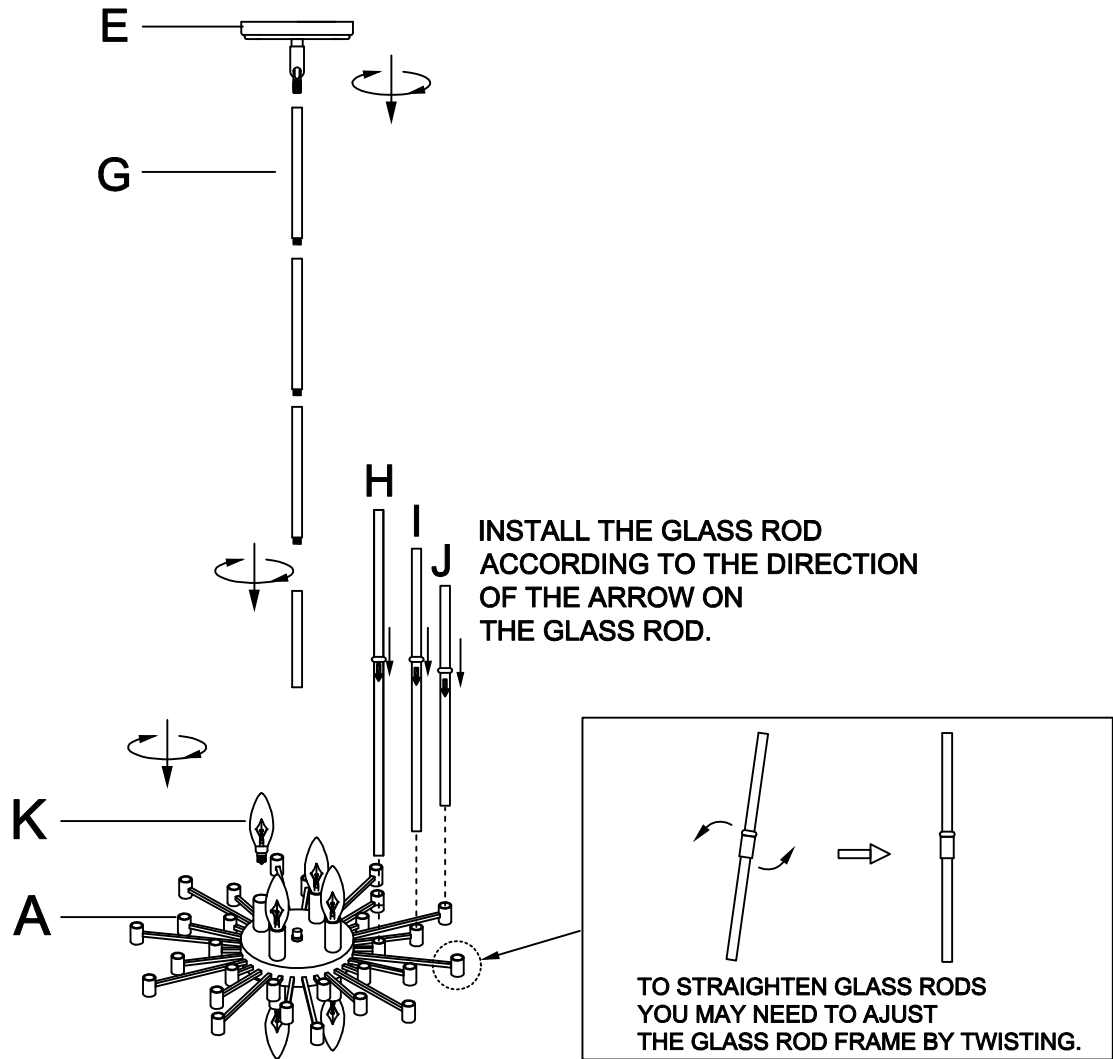

1. Run wire through stems and combine stem lengths to meet desired mounting height.

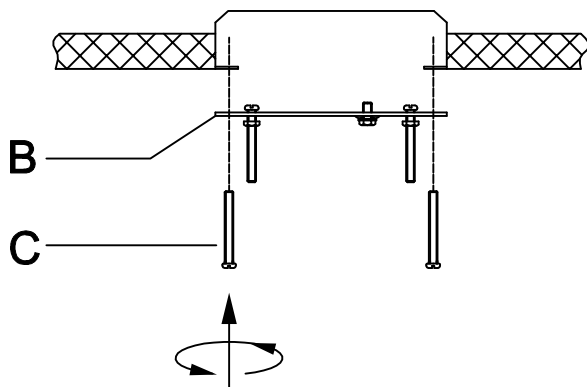

2.

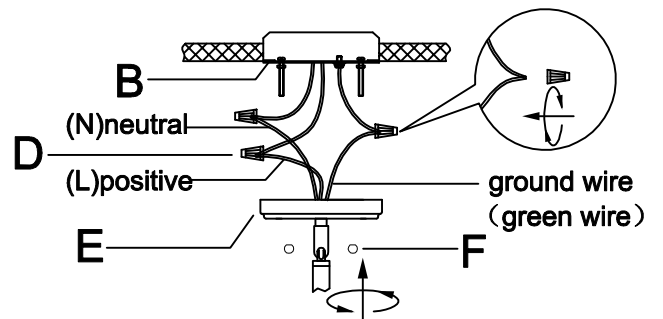

3.