

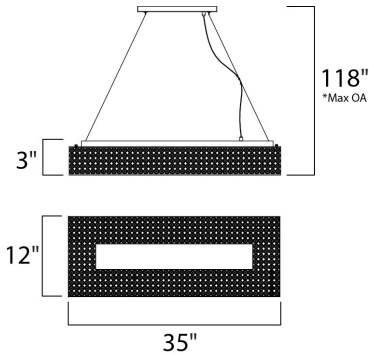

PRODUCT DESCRIPTION

Like a constellation that sparkles in the night, the Glimmer collection features frames of rings expertly crafted and finished in choice of Polished Silver or Bronze. The rings are adorned with hundreds of clear Beveled Crystal beads which are installed one at a time by hand to create a masterpiece of lighting illuminated by xenon lamps



*max overall height

MEASUREMENTS

- DIMENSION : 35" L x 12" W x 3" H
- MAX OAH : 122" OAH
- CANOPY : 4.75" W x 0.79" H x 11.8" L
- HANGING WEIGHT : 19.8 lb

LAMPING

- INPUT VOLTAGE : 120V
- BULB : 1 x 40W Xenon G9 , 400W Total
- BULB INCLUDED : (Included)
- DIMMABLE : Y

FINISHES OPTION

- Plated Silver (PS)

GLASS

Beveled Crystal BC

MATERIAL

Steel, K9 Crystal

RATINGS

cETLus
Dry Location



ADDITIONAL

ADJUSTABLE
RATED LIFE 2000 Hours
OPERATING TEMPERATURE:
-20°C (-4°F), 40°C (104°F)

Always consult a qualified electrician before installing any lighting product.



WESTERN DISTRIBUTION CENTER (HEADQUARTER)
253 NORTH VINELAND AVE | CITY OF INDUSTRY, CA 91746

EASTERN DISTRIBUTION CENTER
101 GARDNER PARK | PEACHTREE CITY, GA 30269

P. 626.956.4200 | F. 626.956.4225 | maximlighting.com